

**CONTECH**<sup>®</sup>  
ENGINEERED SOLUTIONS

Bin-Wall  
Retaining Wall System



## **Contech Bin-Walls**

### **Gravity-Type Retaining Walls**

Contech® Bin-Walls are a system of adjoining closed-faced bins that are each 10-feet wide. They are composed of sturdy, lightweight steel members that are easily bolted together at the job site. Backfilled with reasonable care, they transform the soil mass into an economical gravity-type retaining wall. Because this unique design allows the Bin-Walls to flex against minor, unforeseen ground movements that might damage or destroy rigid-type walls, they have been recognized worldwide for over 60 years as economical and effective retaining walls.

### **Bin-Walls are used to ...**

- Gain right-of-way on highway and railroad projects by either supporting part of the road or holding back an encroaching slope.
- Create usable flat areas on municipal, industrial and commercial sites that otherwise would be wasted slopes.

- Protect against shore or bank erosion.
- Build breakwaters to protect dock areas against wave action.
- Enlarge grade-separated highway or railway rights-of-way.
- Prevent erosion under bridge abutments.
- Provide wingwalls on bridge abutments.
- Create blast walls for protection at military and industrial sites.

### **The benefits of Contech Bin-Walls**

Bin-Walls are easy to install in difficult or restrictive conditions, have a lower initial cost and reduce maintenance expenses. They also have greater strength and stability, are installed without expensive equipment and can be rapidly assembled with unskilled crews.



Contech Bin-Wall is quick and easy to install. It can be bolted together at the job site or preassembled and moved to the site. To the left, a section of preassembled stringers is lowered for bolting to vertical connectors.



## Superior CONTECH Bin-Walls

### Strength with flexibility

CONTECH Bin-Walls gain stability from the weight of the fill material plus the weight of the steel structure itself. But unlike most other types of walls, they are flexible and adjust themselves to minor ground movement without cracking.

### Closed construction

All four sides of each CONTECH Bin-Wall cell are composed of overlapping steel members. Bolted together, they form an integral structure. Because the face of a CONTECH Bin-Wall is fully enclosed, you are protected against loss of fill material. \* This contrasts with crib-type retaining wall construction through which fill material can escape, weakening the structure.

### Versatility

CONTECH Bin-Walls can be readily adapted for installation on curves by shortening the horizontal stringers as needed to shorten either the front or rear wall face.

(See details on Page 14.)

### Appearance options

The rugged modular look and strong horizontal lines of CONTECH Bin-Walls blend well with most environments. The standard galvanized surface weathers gradually to a softer gray.

For harsh environments, ALUMINIZED STEEL Type 2 horizontal face sections (stringers) and transverse sections (spacers) are available depending on the required gauge. Reinforced concrete face panels can usually be produced locally with various finishes. Your CONTECH Sales Engineer can provide you with more information.

### Long service

CONTECH Bin-Walls can withstand temperature variations and effects of ice and snow. Expansion and contraction caused by temperature changes are safely absorbed by the all-steel construction. There is no danger of cracking.

Both the galvanized steel and ALUMINIZED STEEL Type 2 can be sprayed with field-applied coatings after erection and before backfilling.

### No obsolescence

Even after years of use at one location, CONTECH Bin-Walls can be removed for use elsewhere—or they can be easily extended in length to meet changing conditions at the same site.

\* See the backfill material section on page 13



Contech Bin-Wall faced with reinforced concrete panels.



**Typical Bin-Wall Applications**

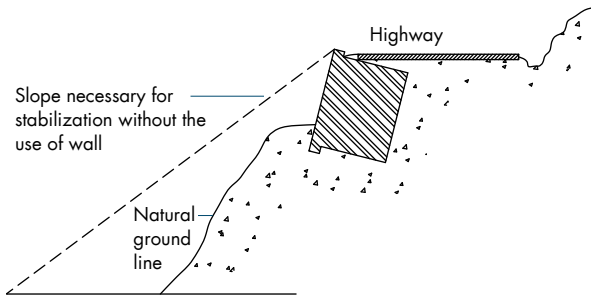

**Eliminating excessive fills with the use of walls**

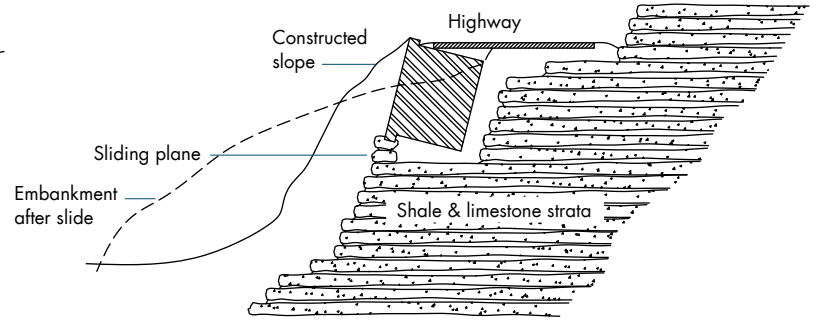

**Repairing break in roadway after slide**

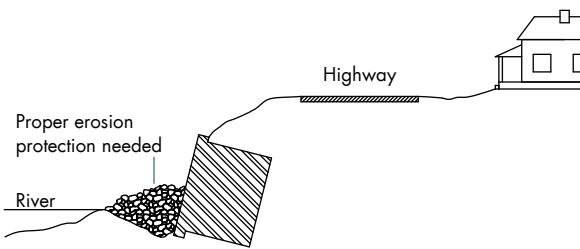

**Preventing encroachment of highway embankment at river bend**

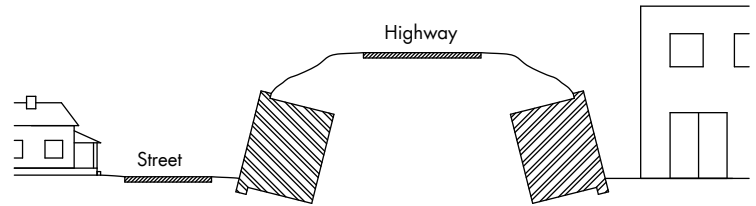

**Solving right-of-way problem on grade separation with twin walls**

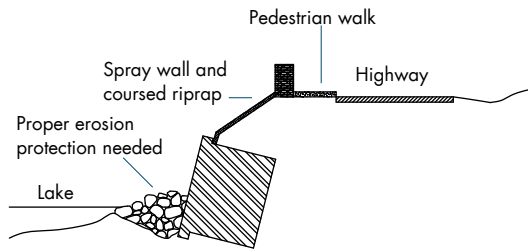

**Wave wall to prevent washout of highway during storms**

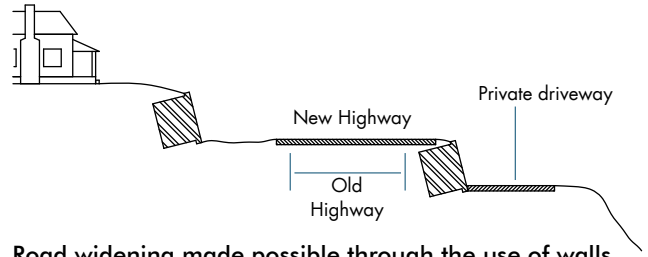

**Road widening made possible through the use of walls**

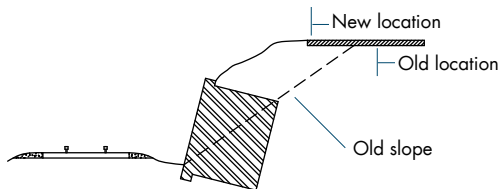

**Solving right-of-way problem when highway is relocated**

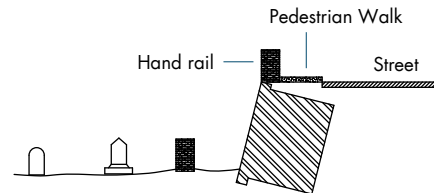

**Avoiding encroachment of street fill on adjacent property**

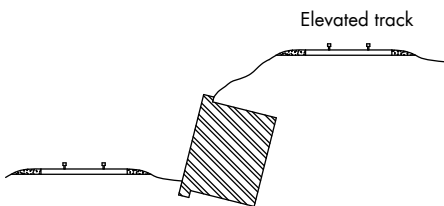

**Stabilizing elevated track on adjacent railroad lines**

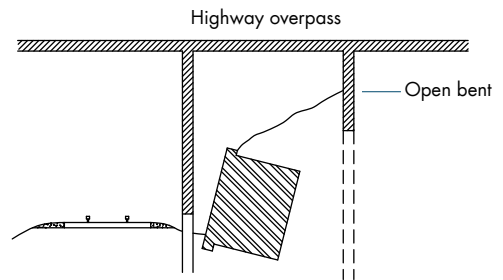

**Preventing encroachment of approach fill on railroad**

## Applications for Contech Bin-Walls Type 1 and Type 2

For retaining walls up to 28 feet, use Contech Bin-Wall Type 2. For walls of greater height or walls requiring increased burst strength, Bin-Wall Type 1 is required.

Bin-Wall Type 1 has heavy-duty vertical connectors, which results in an overall stronger structure.

### Contech Bin-Wall Type 1



Rochester, Monroe County, New York



Two-story Bin-Wall

### Contech Bin-Wall Type 2



This Bin-Wall Type 2 allowed the construction of a parking lot without encroaching on the adjacent railroad right-of-way.



Installed in fresh water, Bin-Wall protects the shoreline from the eroding force of the lake's water.



Bin-Wall allows increased right-of-way for new railroad tracks.

## **Designing Contech Bin-Walls**

The Bin-Wall system is a gravity retaining wall in which an earth mass inside the bins acts as a gravity wall with the steel members holding the earth mass intact. These two components combine to resist soil and other superimposed loads.

This design requires adequate support for the wall under the earth mass. On rigid foundations, provision must be made for slight settlement of the vertical connector members. Normal practice is to provide a compressible cushion under the base plates with approximately eight inches of loose fill.

Individual walls should be designed for stability according to established criteria for gravity walls, available from numerous published documents on the subject of gravity retaining wall design.

While not a substitute for specific site design, Charts A and B may be used to estimate depth-to-height ratios for gravity walls under loading conditions listed in Table 1. This information, based on broad experience, is provided as a guideline only.

**Foundation adequacy is a critical factor in wall design. Ensuring the foundation's resistance to the overturning and sliding forces acting on the wall requires sophisticated engineering evaluation. Proper site investigations and analyses should be performed for any retaining wall installation**

### **Batter vs. Vertical Walls**

Although batter walls are usually the first consideration because of less required depth, vertical Bin-Walls have advantages that should not be overlooked during engineering analysis.

Careful analysis of a given situation will sometimes show that a vertical wall with the same depth as a batter wall will be structurally adequate. At times, a deeper vertical wall will prove more economically desirable when land values are considered.

The usable space gained by using a vertical wall will assume importance under some circumstances. For example, a 24-foot high wall will provide four square feet of valuable land for every frontage foot of wall when compared to a 1:6 batter wall with its toe in the same location.

Invariably, a vertical Bin-Wall is easier to construct on a curve. The shortened panel section (stringer) can be shared by adjacent bins and, when sharp bends are required, special corner plates are usually less complicated and more economical.

It must be remembered that Contech Bin-Walls are flexible structures that will adjust to minor ground move-ments. To allow for this, as well as normal construction tolerances, vertical walls are frequently installed on a slight batter.

The engineer should review the installation procedures on Pages 12 and 13.



**Height-to-depth ratios for Bin-Wall typically require less excavation than cantilever concrete retaining walls or modular block retaining walls.**



**Chart A**  
Bin-Wall Type 1

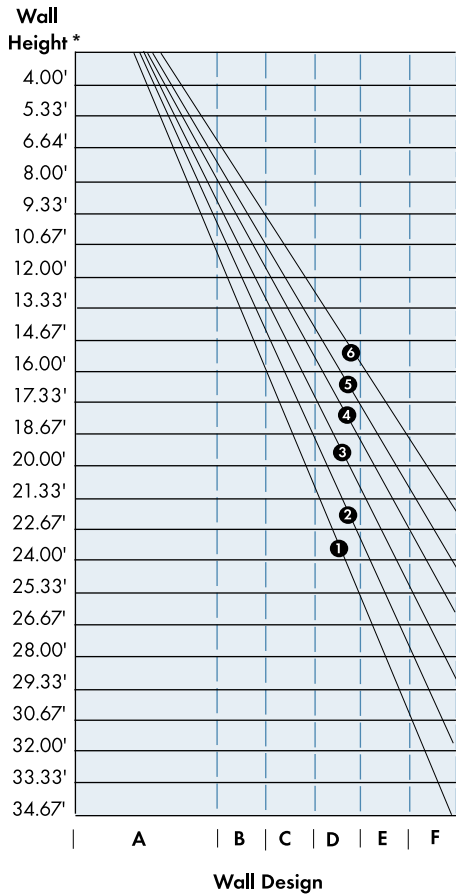

**Chart B**  
Bin-Wall Type 2

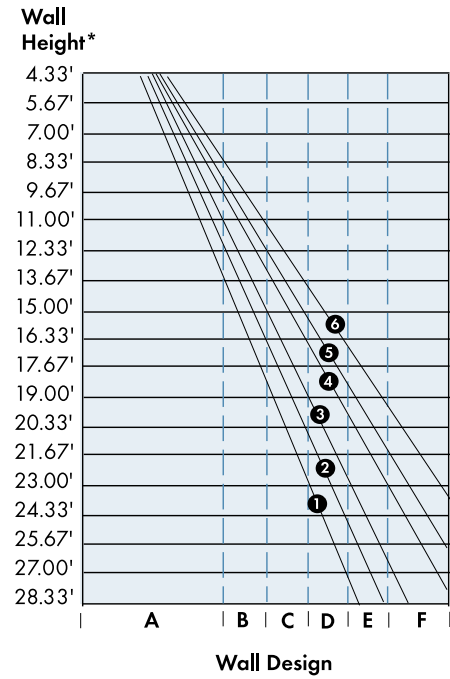

**Table 1**  
Loading Condition

	Batter	Level	Slope With Superimposed Load	Sloping to 3 x D	Sloping above 3 x D
Wall On 1:6 Batter					
Wall Vertical					

\*Wall height is total height, including buried portion.

NOTE: Wall height and depth for Type 1 and Type 2 Bin-Wall designs A through F are shown on page 8 and 9.

# Typical Depth/Height Combinations

## Bin-Wall Type 1

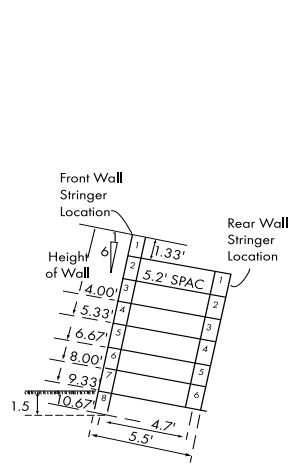

**Design A**

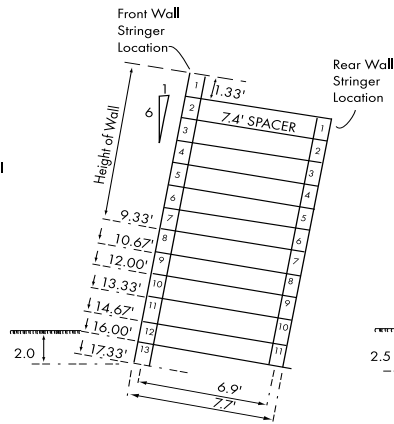

**Design B**

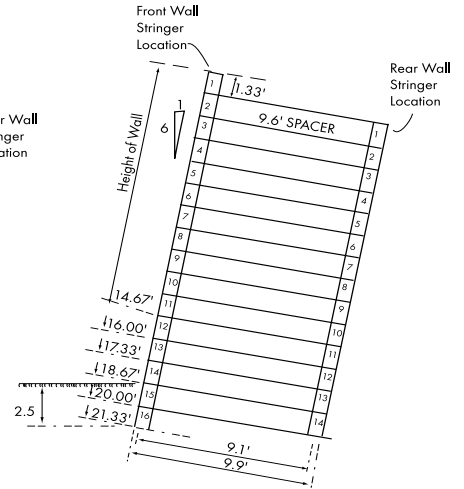

**Design C**

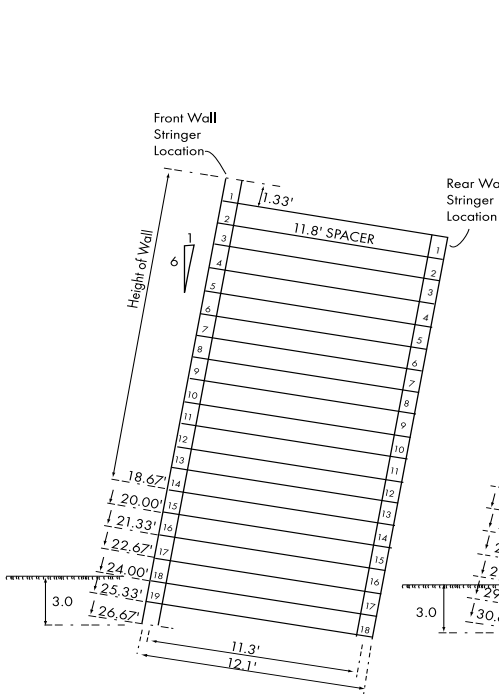

**Design D**

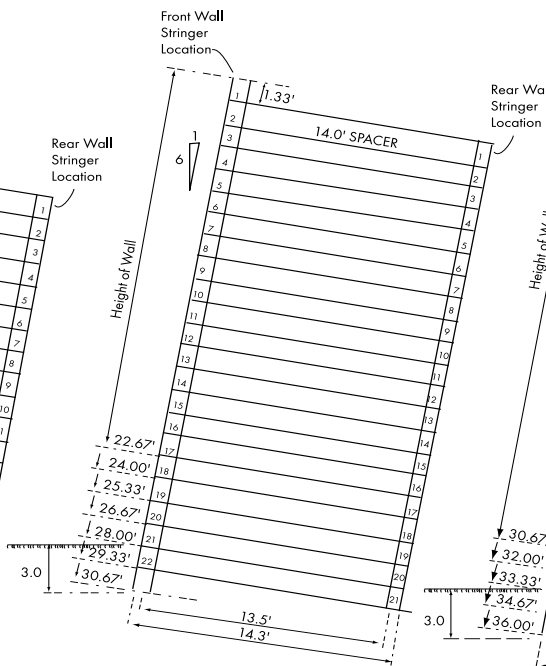

**Design E**

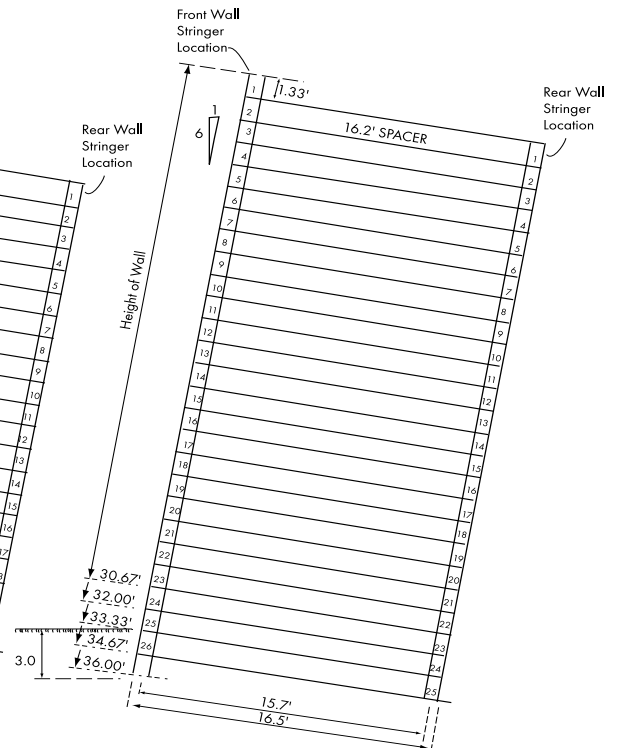

**Design F**



# Bin-Wall Type 2

**Bin-Wall Front and Rear Stringer Steel Thicknesses**

Front Wall Stringer Location Number	Rear Wall Stringer Location Number	Gauge	Specified Thickness (Inches)
1-8	1-6	16	0.064
9-12	7-10	14	0.079
13-19	11-17	12	0.109
Type 2: 20-21	18-19	10	0.138
Type 1: 20-27	18-25	10	0.138

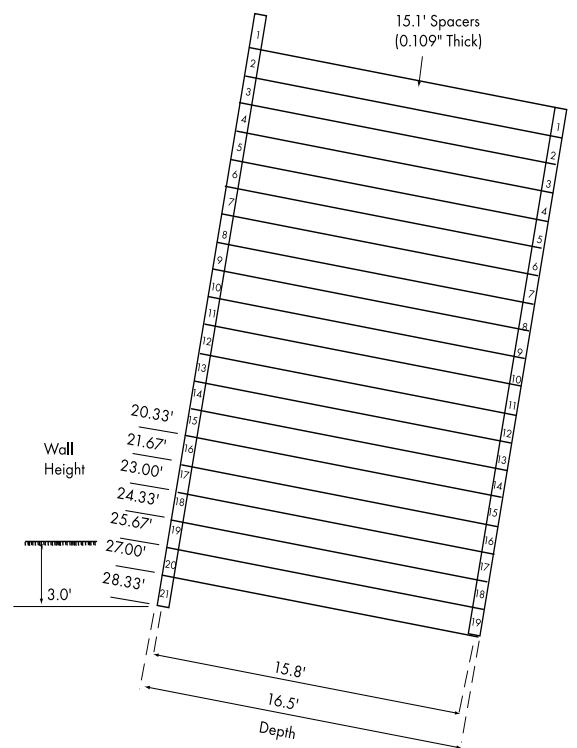
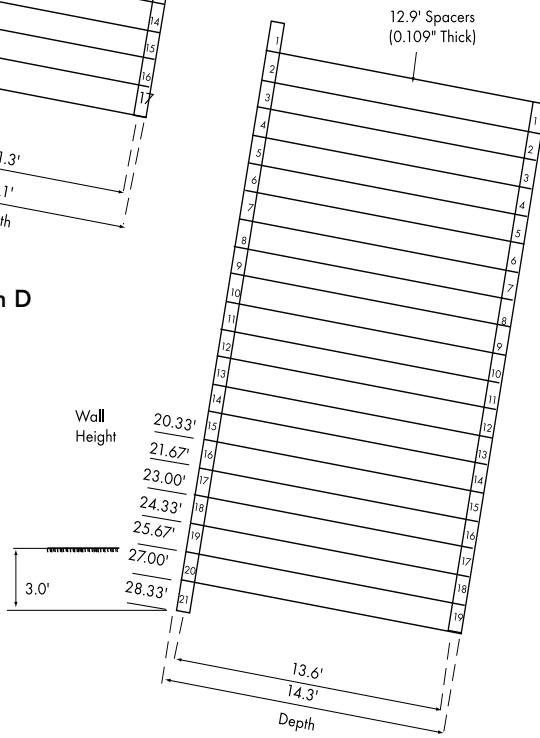
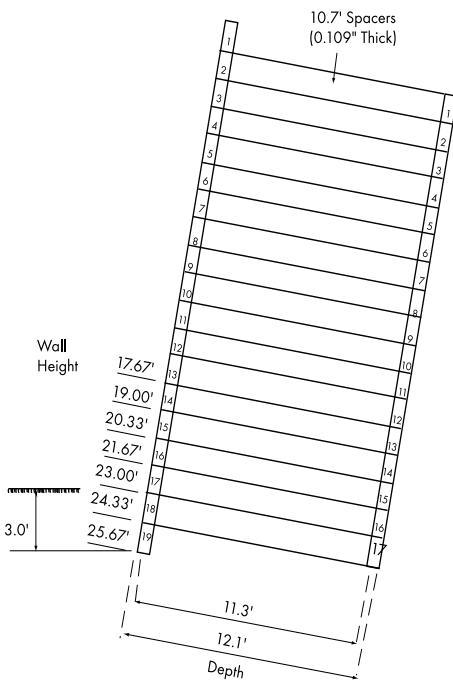
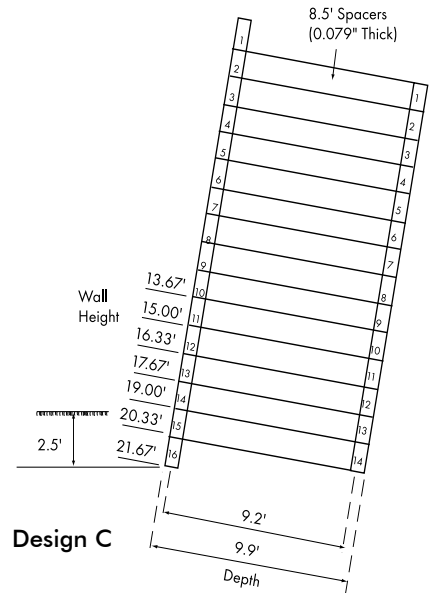
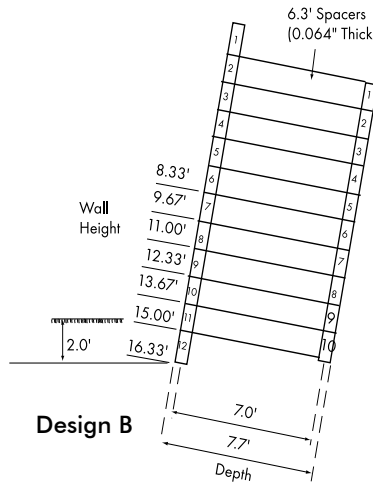
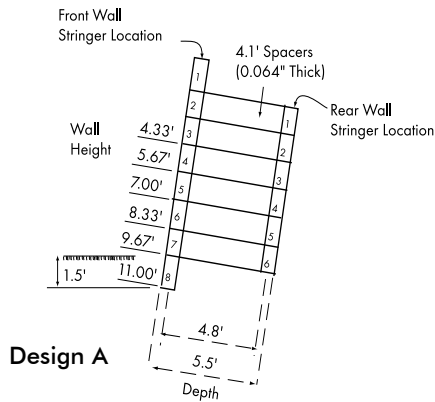

**Contech Bin-Wall Type 1**

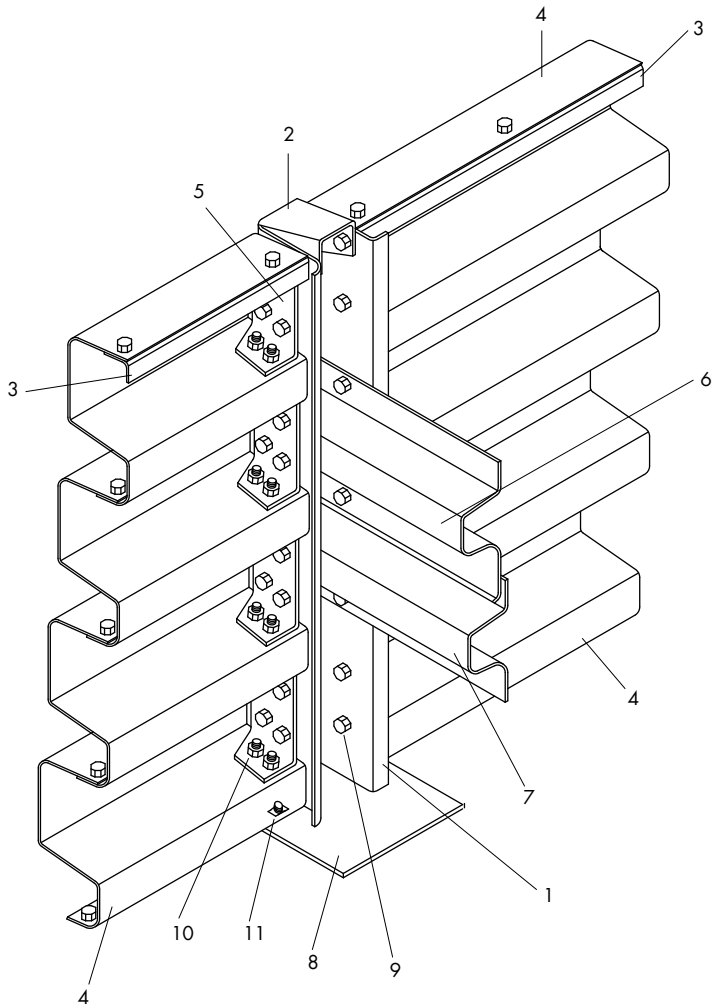

View from back of bin to inside of face. Note how the stringers and spacers are securely joined to the vertical connectors to make a completely closed bin.

**PARTS LIST**

Part	Function
1. Vertical Connector	Connects stringers and spacers
2. Vertical Connector Cap	Cover for front vertical connector
3. Stringer Stiffener	Front face top trim
4. Stringer	Forms front and rear panel sections
5. Connecting Channel	Connector for attaching stringers to vertical connectors
6. Spacer	Forms transverse sections and connects front and rear panels
7. Bottom Spacer	Special bottom transverse member
8. Grade Plate	Leveling pad for vertical connectors
9. 1 1/4" x 5/8" Bolts	Fasteners
10. 5/8" Nuts	Fasteners
11. 5/8" Spring Nuts	Fasteners

# CONTECH Bin-Wall Type 2

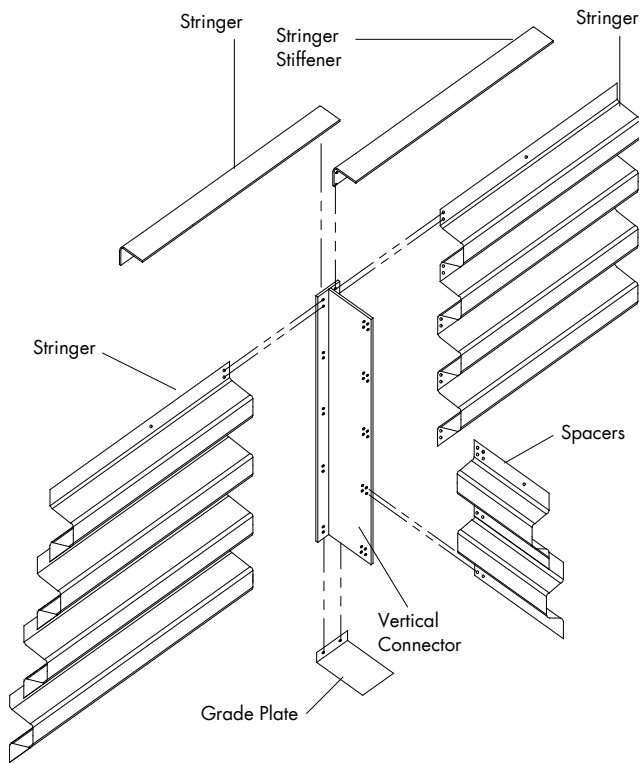

Parts List	
Part	Function
Vertical Connector	Connects stringers and spacers
Corner Vertical Connector	Connects stringers and spacers at ends of wall
Stringer Stiffener	Front face top trim
Stringer	Forms front and rear panel sections
Spacer	Forms transverse sections and connects front and rear panels
Grade Plate	Leveling pad for vertical connectors
5/8" Bolts & Nuts	Fasteners
Split Vertical Connector	Used where bins of different depths meet
Spacer Closure	Retains fill at ends of walls at spacer-stringer junctions
Stringer Closure	Retains fill at special corners at spacer-stringer junctions

## Plan and Elevation

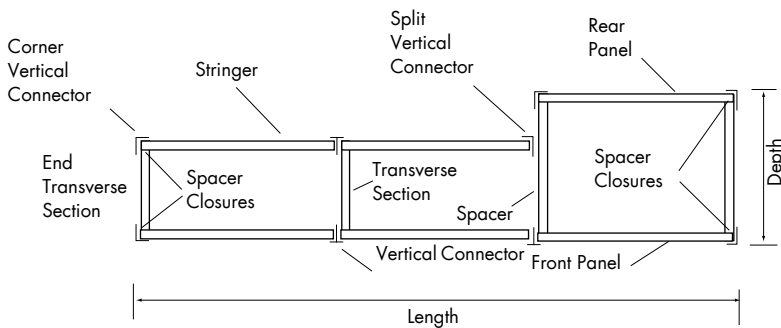

Plan

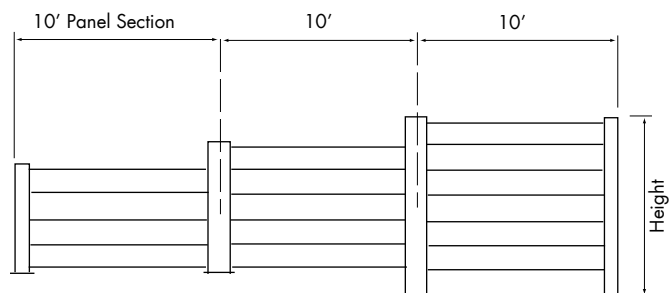

Elevation



## **Installation Procedures**

A small, unskilled crew can quickly erect a Contech Bin-Wall with ordinary contractor's equipment. There is no formwork to build, no curing delays and no follow-up operations.

Assembling the various parts is a simple matter. All Contech Bin-Walls, regardless of height, are made of simple bins having a uniform basic panel length of 10 feet and varying depth. Heavier gauge stringers are used at the bottom of the wall as the height increases. Spacers are the same gauge for the entire height of transverse sections.

Individual parts making up a Contech Bin-Wall are light in weight for easy handling and can be conveniently nested to save space in shipment or at the job site.

### **Less excavation**

By trenching into existing ground that has adequate bearing capacity for the completed wall loads, the earth below the normal ground line need never be disturbed. However,

trench widths and depths must be such that placing and thorough compaction of backfill can be accomplished.

### **All-bolted assembly**

A structural wrench is the only essential tool needed to erect a Contech Bin-Wall. Of course, power wrenches, hoisting equipment and other construction equipment and tools are desirable. Generally, a Contech Bin-Wall, particularly a smaller one, is erected "in place." However, on larger projects, or where unusual working conditions are encountered, it is frequently advantageous to preassemble transverse or panel sections, partially or completely. Simple horizontal supports (such as saw horses) and power equipment will speed assembly of this major wall element. Ordinarily, available lifting equipment can handle large transverse sections.



**Tamping each layer of backfill to optimum density produces the maximum design strength of the Bin-Wall.**

## Backfill material

Next to an adequate foundation, the choice of backfill material is the most important consideration affecting the ultimate performance of the wall. The best material available should be used, keeping in mind that the earth within the bins is the retaining wall.

Your choice of fill material will be influenced by several factors, including the characteristics of the surrounding area, the likelihood of water permeating the wall, the physical configuration of the wall and the material behind it.

An excellent backfill is a graded, granular, pervious material with larger particles in the two-inch range and not more than 10% fines in the 100-mesh size.

Relatively clean bank-run gravels or crusher-run stones are usually suitable. This backfill should not be used, however, when the wall is subject to constant or frequent inundation—as are docks or shore protection structures. Running water or wave action may result in excessive loss of fines and the gradation, therefore, backfill should be modified to eliminate material smaller than  $\frac{1}{8}$ ".

If the only pervious material available for backfill is a fine sand, precautions must be taken to prevent loss of the sand through normal small openings in the wall. Use a geotextile in these areas, thereby retaining the fine sand, yet allowing drainage.

Local soils of a type used for highway fill construction can be used in many instances, but avoid soil with a high clay or silt content.

Regardless of the material used, it must be placed at optimum moisture content and compacted approximately 95% Proctor density.

## Backfill methods

Fill material within and behind the bins should be placed in four- to eight-inch layers and thoroughly compacted with power tampers. Filling the bins should closely follow the assembly of the structure to avoid storm damage or displacement of the bins by earth movement.

Keeping the bin fill above the fill level behind the wall adds stability to the structure. However, working conditions may require that fill be placed behind the wall concurrently with erection and bin filling, but placing fill behind the wall should never precede filling of the bin.

Adequate compaction eliminates damaging drag-down

forces. The amount of compaction required depends on the soil type, lift height and bin height. Since many walls are major structures, extra care is mandatory for this important step, especially on higher walls. Higher degrees of soil compaction are required closer to the base of the wall.

Stringer and spacer corrugations should be filled with compacted material. Always avoid damaging the structural members with equipment.

## Drainage

Adequate drainage of the material in and behind the bins is vital to the performance of the wall. Particular attention is required to the area behind the wall.

Unless absolutely certain that no water will enter this area (either from subsurface sources or from the surface above the wall), perforated pipe, with a positive outlet, surrounded by pervious backfill should be installed behind and below the rear base of the retaining wall.

Above the wall, slopes should be graded to drain and should be protected with vegetation. On all but shallow slopes, intercepting ditches or drains should be considered. If the area above the wall is level, adequate provision for disposal of runoff by grading, paving and/or drains must be made.

Depressions allowing heavy rains to saturate the backfill in and behind the wall should be avoided. At the front of the wall, any condition that allows ponding of water and subsequent softening of material under the toe of the wall should be avoided.

Any unwanted water in, behind or under a bin-type retaining wall can be extremely hazardous. Efforts to ensure that the backfill material has a bearing capacity that is not adversely affected by excess moisture will be advantageous and less costly in the long run.

The general specification will ensure quality and workmanship. Additionally, many state highway departments have prepared standard Bin-Wall specifications, which may be referenced.

## Installing Contech Bin-Wall on Curves

Three methods are commonly used to fit Contech Bin-Walls to specific curvatures. Generally, it is more economical to use standard parts and avoid field fabrication. Vertical walls are almost always more easily built on a curve and should be considered as a preferred alternate to battered walls. Your Contech Sales Engineer can provide more details on the following methods.



Curved Bin-Walls help achieve drainage area cross-section and protect against bank erosion.

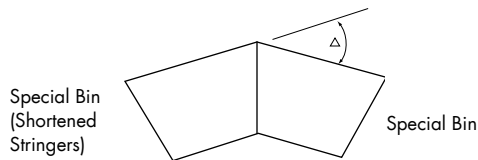

Method 1 — For Vertical Walls Only

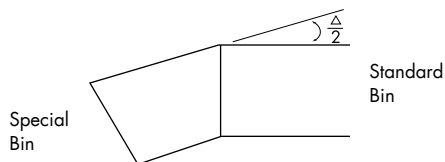

Method 1 — For Vertical and Battered Walls

### Method 1

Method 1 uses special bins, formed by using shorter-than-standard stringers in either the front or rear of the wall. By varying the length of the short stringers, a wide variety of configurations can be created.

With walls on a 1:6 batter, this method causes a slight change of grade in the wall, limiting the number of special bins that can be used. Since the amount of vertical displacement increases with increasing wall heights, height limitations are an important consideration. No such problem occurs on vertical walls and maximum curvatures can be obtained regardless of wall depth or height.

### Method 2

Stringers may be cut and drilled in the field to fit virtually any wall configuration, with the maximum deflection at a vertical connector approximately five degrees. This method is applicable to battered walls by varying the length of the stringers from top to bottom of the bin. On vertical walls, the stringers will be identical from top to bottom.

### Method 3

This method uses shop-fabricated corner plates and there is virtually no limit to the maximum angularity obtainable. However, special details are required to handle outside corners on battered walls—and will need to be determined for specific applications. Additionally, adjacent sections of the wall generally need special design considerations as well.

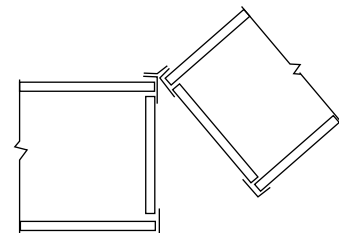

Method 3 — Typical Outside Corner

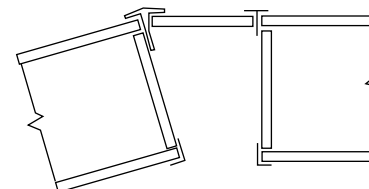

Method 3 — Typical Inside Corner



## Specification for Bin-Wall Types 1 and 2 made from Aluminized Steel Type 2 or Galvanized Steel

### Scope

This specification covers the bin-type retaining walls shown on the plans.

### Material

Aluminized Steel Type 2 and pregalvanized steel materials shall conform to the applicable requirements of ASTM A 929. For **Bin-Wall Type 1**, grade plates shall conform to the applicable requirements of ASTM A 36 with respect to base metal analysis and shall be hot-dip galvanized per ASTM A 123, except coating weight shall be 2 oz. per square foot total both sides. Fasteners are to be 5/8" diameter conforming to ASTM A 307, Grade A. All fasteners are to be galvanized per ASTM A 153, Class C. For **Bin-Wall Type 2**, vertical connectors shall be made from steel that conforms to ASTM A 36 or ASTM A 907 with a 36 ksi (minimum yield) and shall be hot-dip galvanized per ASTM A 123, except coating weight shall be 2 oz. per square foot total both sides. Fasteners are to be 5/8" diameter conforming to ASTM A 307, Grade A.

### Manufacture

The steel Bin-Wall components shall be manufactured to provide overlapping, bolted stringers and spacers. For **Bin-Wall Type 1**, U-shaped vertical connectors, and for **Bin-Wall Type 2**, T-shaped vertical connectors, shall allow for connection of the stringers and spacers at the corners. All components shall be in accordance with the details shown on the plans. The various members of the wall shall be constructed of metal of the gauge shown on the plans, but not less than 16 gauge. They shall be fabricated so that units of the same nominal size and thickness (gauge) are fully interchangeable.

### Assembly

Assembly shall be in conformance with the manufacturer's recommendations and the project plans and specifications.

### Bin Fill

Bin fill material shall be well-graded, clean granular materials having a maximum particle size of 2 inches and having no more than 10% (by weight) passing the #100 sieve. Bin fill shall be placed in 8-inch thick maximum loose lifts and shall be compacted to 95% standard Proctor density. Compaction by saturation is not permitted.

### Backfill

Wall backfill material shall be placed in 8-inch thick maximum loose lifts and shall be compacted to a minimum 90% standard Proctor density. The material shall be free draining and shall be in accordance with the plans. Backfilling behind the bins should not lead the bin-filling process. Soil slopes behind the wall shall be benched as necessary in order to allow for safe and efficient backfill placement and compaction.

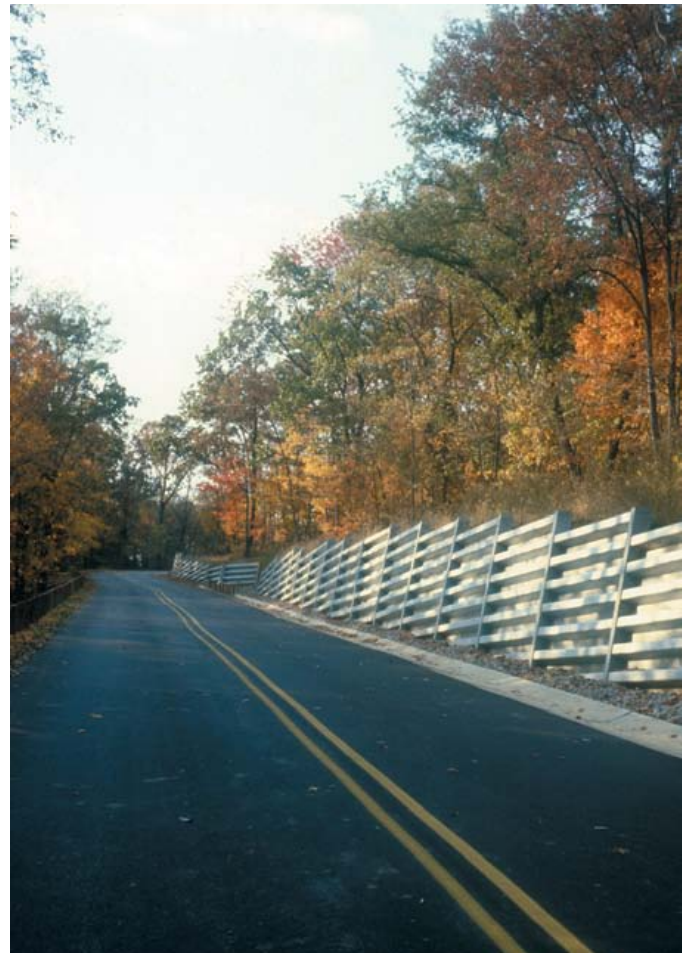

## **Marine Bin-Walls**

### **Breakwaters, Shore Protection, Marina Docks**

Contech Marine Bin-Walls provide economical and effective solutions for many varied marine applications, including shore protection, primary and secondary breakwaters, jetties and marina docks.

The steel-soil design concept provides a unique marine structure with the structural strength and flexibility to withstand freeze and thaw conditions and the effects of ice. For normal freshwater applications, components are supplied as galvanized steel or ALUMINIZED STEEL Type 2 stringers and spacers as specified.

Erection of the relatively lightweight steel bins can be completed off site and then lifted into place. Or, assembly can be performed on site, without requiring heavy equipment. Installation methods are many and varied and are open to the contractor's skill and imagination where difficult or restrictive installation conditions need to be overcome.



Wood fenders can be attached to the bin sides.

Contech Marine Bin-Walls consist of pre-engineered steel members, bolted together to form a closed-face bin. These bins are filled with granular material (1/4" to 6") to provide a durable and sturdy structure.

### **Design**

A critical factor in bin design is the adequacy of the foundation. The resistance of the foundation to the settling, overturning and sliding forces acting on the bin is a sophisticated engineering evaluation. THEREFORE, SITE INVESTIGATIONS AND ANALYSES SHOULD BE COMPLETED BY A PROFESSIONAL ENGINEER.



Bins with 1/4" and larger granular fill material.



Crane lowers a preassembled bin section into place.





Milwaukee, Wisconsin—installed in 1948



Lutz Park, Appleton, Wisconsin—installed in 1975



## **Boat Docks and Marinas**

Contech Marine Bin-Walls are well suited to freshwater marina construction. Placing the steel bins into the water and then filling with granular material (1/4" to 6" provides a structure with a heavy mass to resist overturning, sliding or ice uplift. With fill material smaller than 1/4", a geotextile must be used to prevent loss of fill.

The observed reaction of ice against a Contech Marine Bin-Wall indicates that the mass of the structure is able to resist resultant forces.



**Bin-Wall supports folding slips at Manistique, Michigan Marina**



**Isle Royal, Michigan**



**Municipal Marina, Marquette, Michigan**

## Concrete-Faced Bin-Walls

### Aesthetically Pleasing

Contech Bin-Wall Type 2 with reinforced concrete-faced panels provides an attractive appearance along with strength, flexibility and durability. It also has lower construction costs than heavy, reinforced concrete retaining walls.

Even though the concrete panels cost slightly more than steel stringers used in standard Bin-Wall, installation savings are possible. A standard concrete panel is the equivalent size to two stringers and simply slides into place.



Stepped height can be achieved with different panel treatment.



Bin-Wall system allows angle changes.



Concrete panels easily slide into place.



Concrete-faced bin-wall along interstate highway.



Fill material within and behind the bins should be placed in 4-inch to 8-inch layers and thoroughly compacted with power tampers.





Contech Engineered Solutions provides site solutions for the civil engineering industry. Contech's portfolio includes bridges, drainage, retaining walls, sanitary sewer, stormwater, erosion control, soil stabilization and wastewater treatment products.

**For more information, call a Contech Regional Office:**

<b>Ohio (Corporate Office)</b>	<b>513-645-7000</b>
California (Long Beach)	562-733-0733
Colorado (Denver)	720-587-2700
Florida (Tampa)	727-544-8811
Georgia (Atlanta)	770-409-0814
Maine (Scarborough)	207-885-9830
Maryland (Baltimore)	410-740-8490
Oregon (Portland)	503-258-3180
Texas (Dallas)	972-590-2000

©2012 Contech Engineered Solutions LLC  
800.338.1122  
www.ContechES.com  
All Rights Reserved. Printed in the USA.

NOTHING IN THIS CATALOG SHOULD BE CONSTRUED AS AN EXPRESSED WARRANTY OR AN IMPLIED WARRANTY OF MERCHANTABILITY OR FITNESS FOR ANY PARTICULAR PURPOSE. SEE THE CONTECH STANDARD CONDITIONS OF SALE (VIEWABLE AT [WWW.CONTECHES.COM/COS](http://WWW.CONTECHES.COM/COS)) FOR MORE INFORMATION.

Get Social With Us!

