

INSTALLATION GUIDELINES

FOR LANDLOK® TRMs AND PYRAMAT® HPTRMs

BEFORE YOU BEGIN

Thank you for purchasing high quality Landlok® Turf Reinforcement Mats (TRMs) and Pyramat® High Performance Turf Reinforcement Mats (HPTRMs) from Propex. We're committed to offering the best erosion control products in the industry.

It is important to follow these installation guidelines for a successful project. (Note: Construction shall be performed in accordance with the specific project bid documents, construction drawings, and specifications.) In addition, we suggest that a pre-installation meeting be held with the construction team and a representative from Propex. This meeting shall be scheduled by the contractor with at least two weeks notice. Also, Propex suggests that installation monitoring of our TRMs and HPTRMs be performed by a qualified independent third party.

SITE PREPARATION

- ▶ Grade and compact area of TRM/HPTRM installation as directed and approved by Engineer. Subgrade shall be uniform and smooth. Remove all rocks, clods, vegetation or other objects so the installed mat will have direct contact with soil surface.
- ▶ Prepare seedbed by loosening the top 2-3 in (50-75 mm) minimum of soil.
- ▶ Incorporate amendments such as lime and fertilizer and/or wet the soil, if needed.
- ▶ Do not mulch areas where mat is to be placed.

SEEDING

- ▶ Apply seed to soil surface before installing mat. Disturbed areas shall be reseeded.
- ▶ When soil filling, first install the mat, apply seed and then soil-fill per guidelines (see page 8).
- ▶ Consult project plans and/or specifications for seed types and application rates.

INSTALLATION GUIDELINES

FOR LANDLOK® TRMs AND PYRAMAT® HPTRMs

INSTALLATION ON STABLE SOIL SLOPES

- ▶ Excavate a 12 x 6 in (300 x 15 mm) minimum longitudinal anchor trench 2-3 ft (600-900 mm) over crest of slope (see Figure 2).
- ▶ Install top end of mat into trench and secure to bottom using suggested ground anchoring devices (see Tables 1 and 2 on page 7) spaced every 12 in (300 mm) minimum. Backfill and compact soil into trench (see Figure 2).
- ▶ Unroll mat down slope. Landlok® 1051 shall have the geotextile on bottom.
- ▶ Overlaps shall be 6 in (150 mm) minimum and anchored every 18 in (450 mm) minimum along the overlap. Secure using suggested ground anchoring devices shown in Table 1 for appropriate frequency and pattern. Overlaps are shingled away from prevailing winds (see Figure 1).
- ▶ Unroll mat in a manner to maintain direct contact with soil. Secure mat to ground surface using ground anchoring devices (see Table 1). Anchors shall be placed in accordance with the Anchor Pattern Guide on page 7.
- ▶ Excavate a 12 x 6 in (300 x 150 mm) key anchor trench at toe of slope (see Figure 3).
- ▶ Place bottom end of mat into key anchor trench at toe of slope and secure to bottom of trench using suggested ground anchoring devices (see Tables 1 and 2) spaced every 12 in (300 mm) minimum. Backfill and compact soil into trench (see Figure 3).
- ▶ If the potential for standing and/or flowing water exists at the toe of slope, the key anchor trench at the toe detail (see Figure 3) is not sufficient. Consult the project engineer for the appropriate detail.
- ▶ Irrigate as necessary to establish/maintain vegetation. Do not over-irrigate.

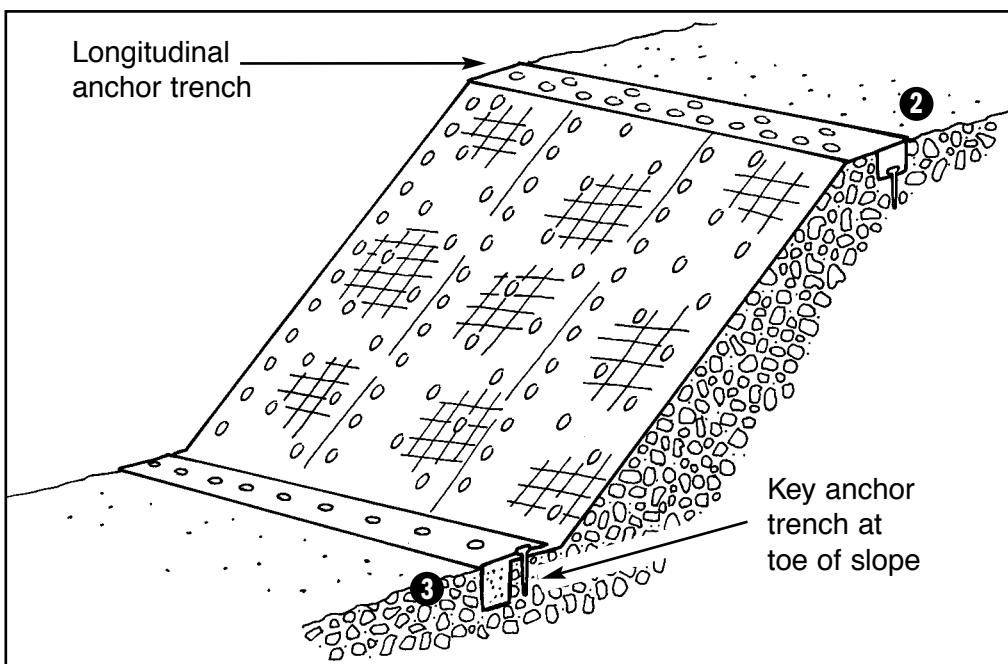

FIGURE 1

Installation of permanent turf reinforcement mat on slope

- Overlaps 6 in (150 mm) minimum
- Space anchors 18 in along overlaps down the slope
- Anchor pattern shall be in accordance with the "Anchor Pattern Guide" found on page 7

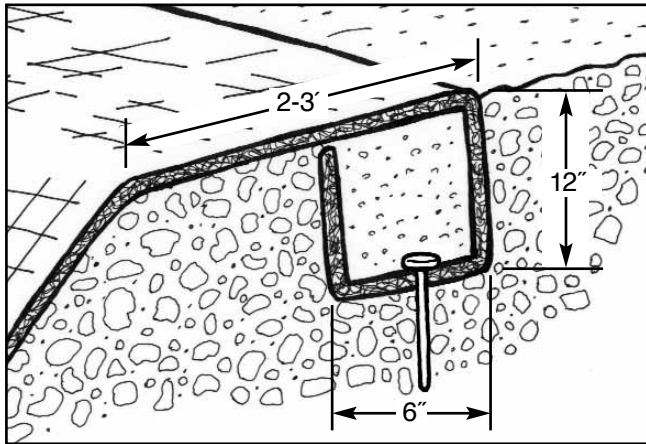

FIGURE 2

Longitudinal anchor trench at top of slope

- Space anchors 12 in (300 mm) along bottom of trench

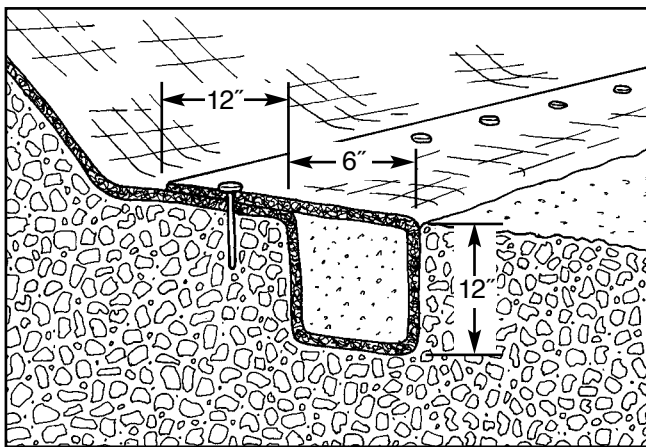

FIGURE 3

Key anchor trench at toe of slope

INSTALLATION IN STORM WATER CHANNELS

- ▶ Figure 4 shows general installation layout and details for TRMs and HPTRMs in storm water channels.
- ▶ Excavate an initial anchor trench 12 in (300 mm) minimum deep and 12 in (300 mm) minimum wide across the channel at downstream end of project (see Figure 5). Deeper initial anchor trench is needed in channels that have the potential for scour.
- ▶ Excavate longitudinal anchor trenches 12 in (300 mm) minimum deep and 6 in (150 mm) minimum wide along both sides of the installation to bury edges of mat (see Figure 6). The trench shall be located 2-3 ft (600-900 mm) over crest of slope.
- ▶ Place roll end into the initial anchor trench and secure with anchoring devices at 12 in (300 mm) minimum intervals (see Figure 5). Position adjacent rolls and secure in anchor trench in same manner. Backfill and compact soil into trench.
- ▶ Unroll mat in the upstream direction over the compacted trench.
- ▶ Continue installation as described above, overlapping adjacent rolls as follows:
 - Roll edge: 6 in (150 mm) minimum with upslope mat on top. Secure with one row of ground anchoring devices on 12 in (300 mm) minimum intervals (see Figure 7).
 - Roll end: 12 in (300 mm) minimum with upstream mat on top. Secure with two rows of ground anchoring devices staggered 12 in (300 mm) minimum apart on 12 in (300 mm) minimum intervals (see Figure 8).
- ▶ Fold and secure mat rolls snugly into intermittent check slots. Lay mat in the bottom and fold back against itself. Anchor through both layers of blanket or mat at 1 ft (300 mm) intervals then backfill and compact soil (Figure 9). Continue rolling upstream over the compacted slot to the next check slot or terminal anchor trench. Check slots are placed at 25 to 30 ft (7.6 to 9.1 m) intervals perpendicular to flow.

INSTALLATION GUIDELINES

FOR LANDLOK® TRMs AND PYRAMAT® HPTRMs

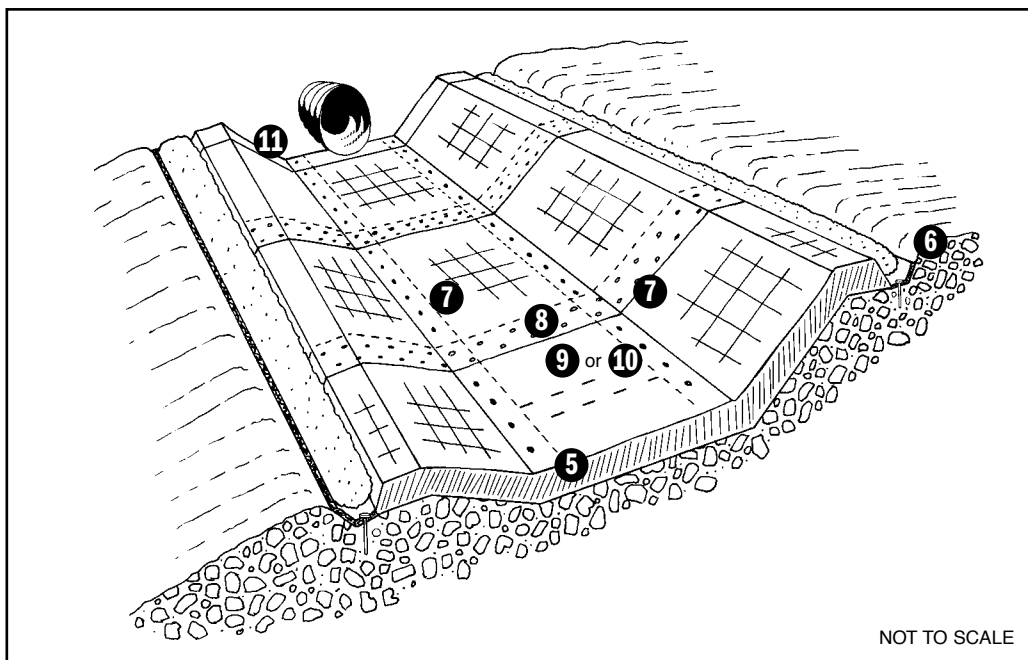

FIGURE 4 Installation of TRMs & HPTRMs in storm water channels

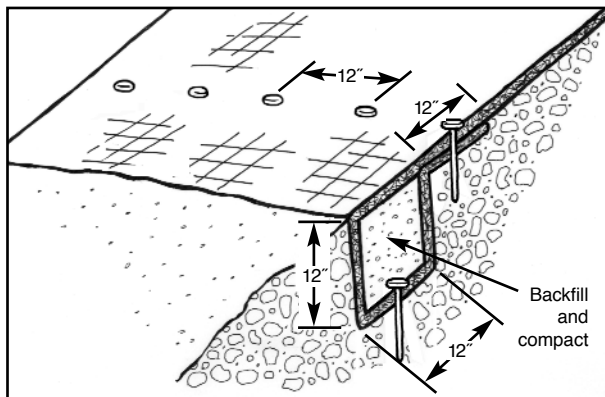

FIGURE 5 Initial anchor trench (downstream) detail

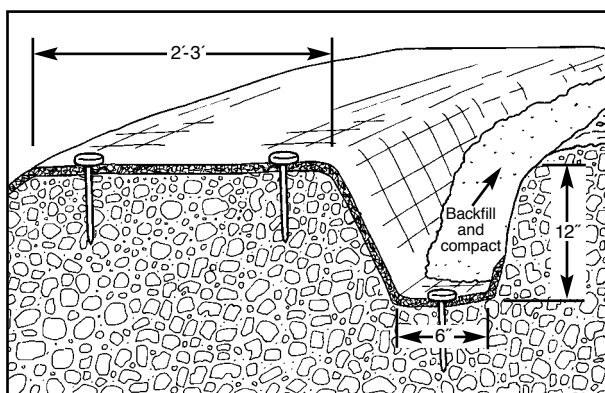

FIGURE 6 Longitudinal anchor trench detail (trapezoidal channel)

- ▶ An alternate method to the intermittent check slot is the simulated check slot. This method includes placing two staggered rows of anchors on 4 in (100 mm) centers at 30 ft (9.1 m) intervals (see Figure 10).
- ▶ Excavate terminal anchor trench 12 in wide x 12 in deep (300 x 300 mm) minimum across the channel at the upstream end of the project (see Figure 11). Deeper terminal anchor trench is needed in channels that have the potential for scour.
- ▶ Anchor, backfill and compact upstream end of mat in 12 x 12 in (300 x 300 mm) minimum terminal anchor trench (see Figure 11). Unroll mat in downstream direction over compacted trench with a minimum 2 ft (600 mm) lap. Secure with anchors in accordance with Figure 8.
- ▶ Secure mat using suggested ground anchoring devices (see Tables 1 and 2 on page 7) for appropriate frequency and pattern (see Anchor Pattern Guide on page 7).
- ▶ Seed and fill with soil for enhanced performance. See Soil Filling Section on page 8.
- ▶ When using Landlok® 1051, seed after installing mat and then fill with soil.
- ▶ Irrigate as necessary to establish/maintain vegetation. Do not over irrigate.

NOTE: If you encounter roll with factory overlap, install factory seam such that it shingles in the direction of the flow of water. Place anchoring devices in accordance with Figure 8 "Overlap at roll end" on page 5.

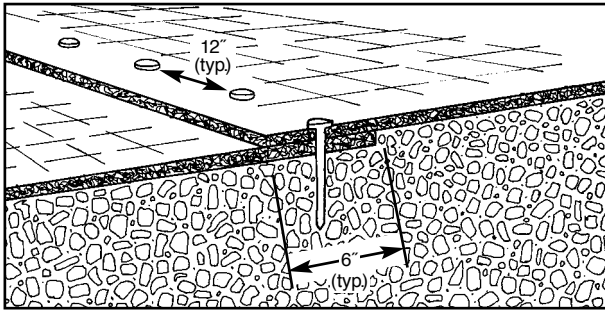

FIGURE 7 Overlap at roll edge

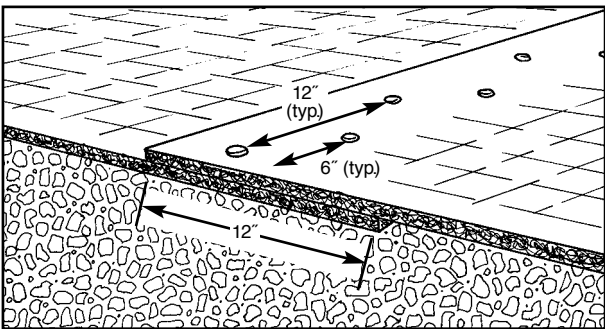

FIGURE 8 Overlap at roll end

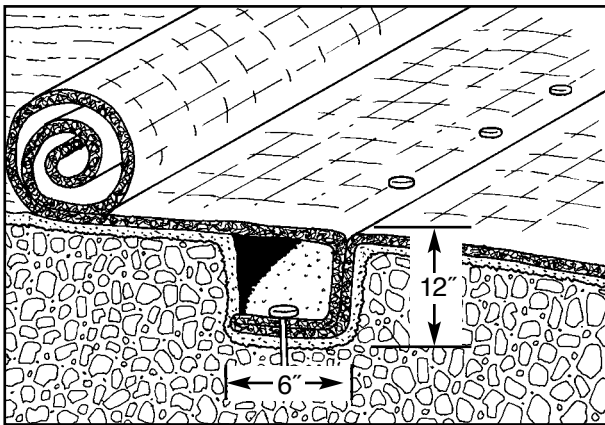

FIGURE 9 Intermittent check slot (channels)

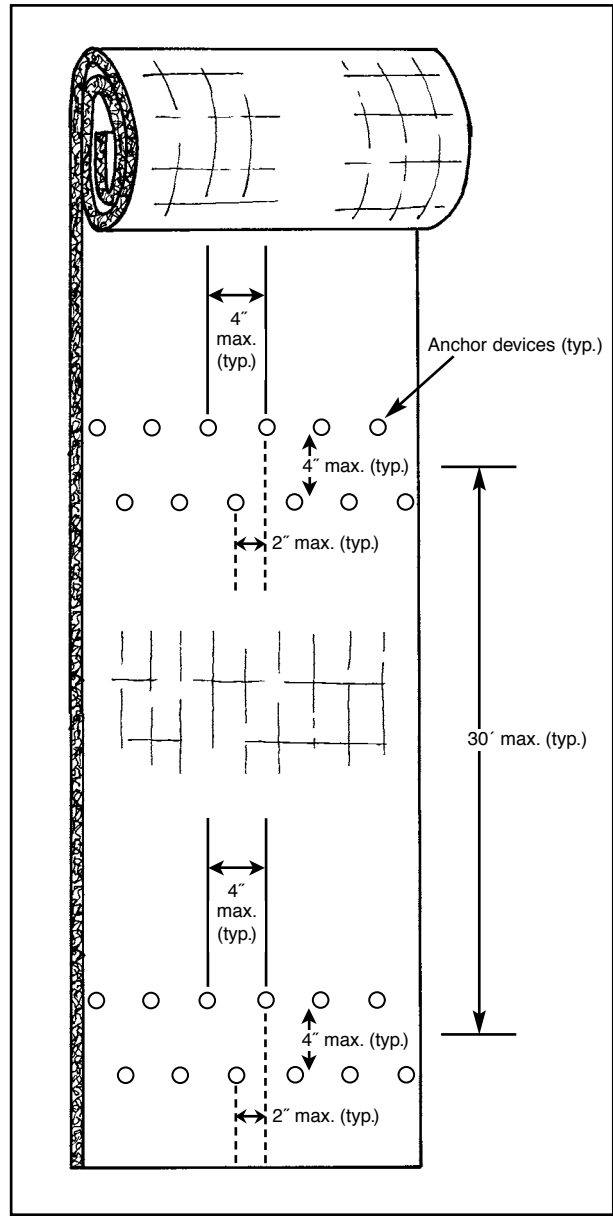

FIGURE 10 Simulated check slot

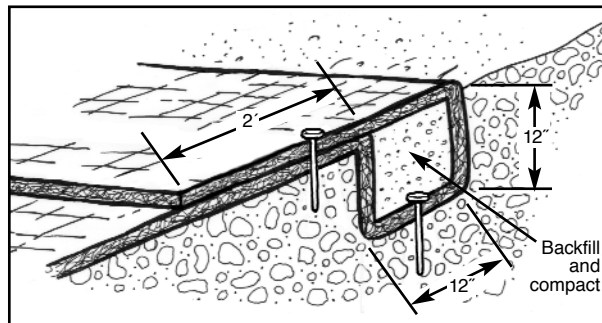

FIGURE 11 Terminal anchor trench (upstream) detail

INSTALLATION GUIDELINES

FOR LANDLOK® TRMs AND PYRAMAT® HPTRMs

SPECIAL TRANSITION GUIDELINES

► Rock Riprap

- Excavate an anchor trench 12 x 12 in (300 x 300 mm) minimum at the transition between the mat and the rock riprap.
- Place roll end into anchor trench and secure with suggested anchoring devices at 12 in (300 mm) minimum intervals. Position adjacent rolls and secure in anchor trench in same manner.
- Backfill the anchor trench with rock riprap.
- Place rock riprap as specified, extending approximately 3 ft (1 m) minimum beyond the anchor trench onto the mat.

► Concrete

· Alternative 1: Concrete Apron

- Place ready mixed concrete directly onto a 3 ft (0.9 m) wide minimum strip of mat.

· Alternative 2: Concrete Backfill

- Excavate an anchor trench 12 x 12 in (300 x 300 mm) minimum at the edge of the concrete structure.
- Place roll end into anchor trench and secure with suggested anchoring devices at 12 in (300 mm) minimum intervals. Position adjacent rolls and secure in anchor trench in same manner.
- Backfill trench with concrete slurry.

· Alternative 3: Bolt to Structure (HPTRMs Only)

- Cast threaded dowel in fresh ready mix concrete or install expanding bolt into cured concrete. Then affix HPTRM with washer (minimum 2 in or 50 mm diameter) or batten strip and bolt.

► Pipe Inlets/Outlets (HPTRMs Only)

- Review the construction drawings and project specifications to evaluate the required area to be treated.
- Excavate an anchor trench 12 x 12 in (300 x 300 mm) minimum above the pipe to bury end of HPTRM roll. The trench shall be located a minimum 2-3 ft (600-900 mm) above the pipe inlet/outlet.
- Backfill and compact soil into trench.
- Cut HPTRM to meet project requirements, slope length and pipe diameter.
- Unroll HPTRM down the slope and secure around pipe circumference with ground anchoring devices spaced 6 in (150 mm) minimum. Also, the HPTRM can be secured around the pipe in a 12 x 12 in (300 x 300 mm) minimum trench filled with concrete slurry.

GROUND ANCHORING DEVICES

- Ground anchoring devices are used to secure the mat to the soil using the suggested anchor device (see Tables 1 and 2 on page 7) at a minimum frequency and pattern shown on the Anchor Pattern Guide on page 7.
- U-shaped wire staples or metal geotextile pins can be used to anchor mat to the ground surface. Wire staples should be a minimum thickness of 8 gauge (4.3 mm). Metal pins should be at least 0.20 in (5 mm) diameter steel with a 1 1/2 in (38 mm) steel washer at the head of the pin. Wire staples and metal pins should be driven flush to the soil surface. All anchors should be between 6-24 in (150-600 mm) long and have sufficient ground penetration to resist pullout. Longer anchors may be required for loose soils. Heavier metal stakes may be required in rocky soils.

TABLE 1: SUGGESTED GROUND ANCHORING DEVICE SELECTION*

	DEGRADABLE STAKES	WIRE STAPLES	METAL PIN/WASHERS OR NAIL/WASHERS	PERCUSSION DRIVEN ANCHORS
PRODUCT	LANDLOK® ECBs	●	●	
	LANDLOK® TRMs		●	●
	PYRAMAT®		●	●
APPLICATION	SLOPES	●	●	●
	BANKS			●
	CHANNELS		●	●

TABLE 2: SUGGESTED LENGTHS OF GROUND ANCHORING DEVICES*

	6-INCH	12-INCH	18-INCH	24-INCH
SOIL TYPES	ROCKY	●		
	CLAYEY	●	●	
	SILTY		●	●
	SANDY			●

*The performance of ground anchoring devices is highly dependent on numerous site/project specific variables. It is the sole responsibility of the project engineer and/or contractor to select the appropriate anchor type and length. Anchoring shall be selected to hold the mat in intimate contact with the soil subgrade and resist pullout in accordance with the project's design intent.

ANCHOR PATTERN GUIDE

► The shaded areas in the diagram provide anchor suggestions based on slope gradient and/or anticipated flow conditions. When the correct number of anchors has been determined, refer to the four illustrations below to establish anchor pattern. Increased anchoring may be required depending upon site conditions.

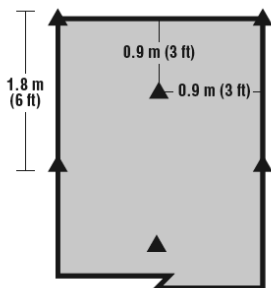
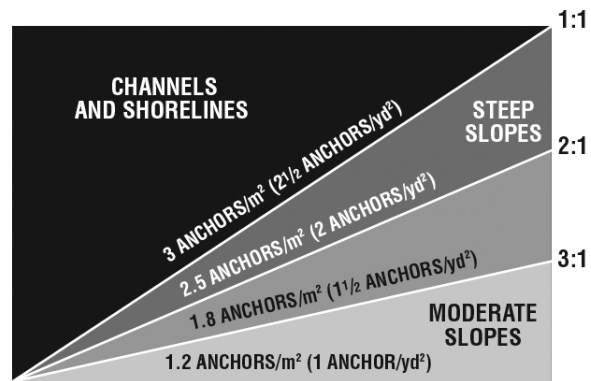

1.2 ANCHORS/m²
(1 ANCHOR/yd²)

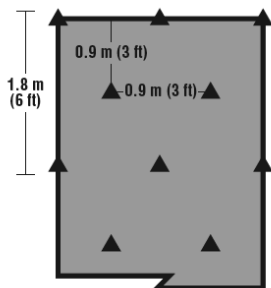

1.8 ANCHORS/m²
(1½ ANCHORS/yd²)

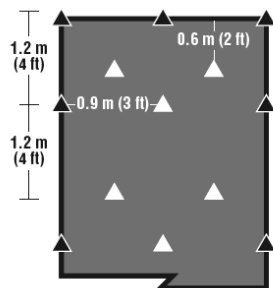

2.5 ANCHORS/m²
(2 ANCHORS/yd²)

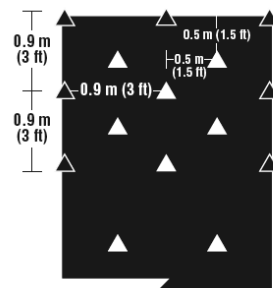

3 ANCHORS/m²
(2½ ANCHORS/yd²)

SOIL FILLING

- ▶ Soil filling is suggested for optimum performance.
- ▶ After seeding, spread and lightly rake $\frac{1}{2}$ - $\frac{3}{4}$ in (12-19 mm) minimum of fine site soil or topsoil into the mat and completely fill the voids using backside of rake or other flat tool.
- ▶ If equipment must operate on the mat, make sure it is of the rubber-tired type. No tracked equipment or sharp turns are allowed on the mat.
- ▶ Avoid any traffic over the mat if loose or wet soil conditions exist.
- ▶ Smooth soil-fill in order to just expose the top netting of matrix. Do not place excessive soil above the mat.
- ▶ Broadcast additional seed and install a Landlok® ECB above the soil-filled mat (if desired).
- ▶ Hydraulically-applied mulch or seed may be used as an alternate to soil-fill on select applications. Consult manufacturer's technical representative for more information.
- ▶ Consult manufacturer's technical representative or local distributor for installation assistance, particularly if unique conditions apply (sandy soils and infertile environments).

MAINTENANCE

All slopes, channels, banks and other transition structures shall be maintained to assure the expected design life of the reinforced vegetated system. Here are a few tips that should prove helpful:

- ▶ **Monitoring**
 - Should be conducted semi-annually and after major storm events. This should include: observing the condition of the vegetation; testing the irrigation system; checking condition of all permanent erosion control systems; observing sediment and debris deposits that need removal.
- ▶ **Vegetation**
 - Repair and maintenance of various types of vegetation shall be consistent with their original design intent, including:
 - Grass/Turf Areas: applications shall be maintained for adequate cover and height.
 - Mowing: grasses shall be mowed according to normal maintenance schedules as determined by local jurisdictions or maintenance agreements; operations shall not start until vegetation achieves a minimum height of 6 in (150 mm); mower blades shall be greater than 6 in (150 mm) above the mat.
 - Unvegetated Areas: shall be re-seeded and soil-filled (if applicable).
- ▶ **Sediment and Debris Deposits**
 - Accumulation of sediment and debris can reduce the hydraulic capacity of channels, clog inlet and outlet structures and can damage existing vegetation. Sediment and debris removal is a vital part of system maintenance.
 - Removal: shall be done carefully to avoid damage. When excavation is within 12 in (300 mm) minimum of matting, removal shall be done by hand or with a visual "spotter." If equipment must operate on the mat, make sure it is of the rubber-tired type. No tracked equipment or sharp turns are allowed on the mat.
 - Alternatively, "stake chasers" or some other form of permanent visual markers can be utilized to provide a visual marker for maintenance activities.
- ▶ **Damaged Sections**
 - Missing or damaged sections of the matting should be replaced per the installation guidelines.
 - Repairing Rips or Holes: these should be patched with identical matting material. First, carefully cut out the damaged section with a knife. Then replace and compact soil to the elevation of the surrounding subgrade and plant seed. Cut a piece of replacement material a minimum of 12 in (300 mm) larger than the rip or tear. Use ties to attach the replacement material to the existing material. At overlaps, the upstream and upslope material should be on top. Secure the replacement material with ground anchoring devices spaced every 6 in (150 mm) around the circumference of the repair and at the frequency and spacing shown in the Anchor Pattern Guide on page 7. Seed and soil fill replacement area.



THE ADVANTAGE CREATORS.™

Propex Inc.
6025 Lee Highway, Suite 425
PO Box 22788
Chattanooga, TN 37422

PH: 423 899 0444
PH: 800 621 1273
FAX: 423 899 7619
www.geotextile.com

Geotex®, Landlok®, Pyramat®, X3®, SuperGro®, Petromat®, Petrotac®, Pro-Guard® and PetroGrid® are registered trademarks of Propex Inc.

THIS PUBLICATION SHOULD NOT BE CONSTRUED AS ENGINEERING ADVICE. WHILE INFORMATION CONTAINED IN THIS PUBLICATION IS ACCURATE TO THE BEST OF OUR KNOWLEDGE, PROPEX DOES NOT WARRANT ITS ACCURACY OR COMPLETENESS. THE ULTIMATE CUSTOMER AND USER OF THE PRODUCTS SHOULD ASSUME SOLE RESPONSIBILITY FOR THE FINAL DETERMINATION OF THE SUITABILITY OF THE INFORMATION AND THE PRODUCTS FOR THE CONTEMPLATED AND ACTUAL USE. THE ONLY WARRANTY MADE BY PROPEX FOR ITS PRODUCTS IS SET FORTH IN OUR PRODUCT DATA SHEETS FOR THE PRODUCT, OR SUCH OTHER WRITTEN WARRANTY AS MAY BE AGREED BY PROPEX AND INDIVIDUAL CUSTOMERS. PROPEX SPECIFICALLY DISCLAIMS ALL OTHER WARRANTIES, EXPRESS OR IMPLIED, INCLUDING WITHOUT LIMITATION, WARRANTIES OF MERCHANTABILITY OR FITNESS FOR A PARTICULAR PURPOSE, OR ARISING FROM PROVISION OF SAMPLES, A COURSE OF DEALING OR USAGE OF TRADE.